

# BLF6G20-75; BLF6G20LS-75

Power LDMOS transistor

Rev. 02 — 9 February 2009

Product data sheet

## 1. Product profile

### 1.1 General description

75 W LDMOS power transistor for base station applications at frequencies from 1800 MHz to 2000 MHz.

**Table 1. Typical performance**

*RF performance at  $T_{case} = 25\text{ }^{\circ}\text{C}$  in a common source class-AB production test circuit.*

Mode of operation	f (MHz)	V <sub>DS</sub> (V)	P <sub>L(AV)</sub> (W)	G <sub>p</sub> (dB)	$\eta_D$ (%)	ACPR <sub>400k</sub> (dBc)	ACPR <sub>600k</sub> (dBc)	EVM <sub>rms</sub> (%)
CW	1930 to 1990	28	63	19	52	-	-	-
GSM EDGE	1930 to 1990	28	29.5	19	37.5	-61.5	-73	1.7

#### CAUTION



This device is sensitive to ElectroStatic Discharge (ESD). Therefore care should be taken during transport and handling.

### 1.2 Features

- Typical GSM EDGE performance at frequencies of 1930 MHz and 1990 MHz, a supply voltage of 28 V and an I<sub>DQ</sub> of 550 mA:
  - ◆ Average output power = 29.5 W
  - ◆ Gain = 19 dB
  - ◆ Efficiency = 37.5 %
  - ◆ ACPR<sub>400k</sub> = -61.5 dBc
  - ◆ ACPR<sub>600k</sub> = -73 dBc
  - ◆ EVM<sub>rms</sub> = 1.7 %
- Easy power control
- Integrated ESD protection
- Excellent ruggedness
- High efficiency
- Excellent thermal stability
- Designed for broadband operation (1800 MHz to 2000 MHz)
- Internally matched for ease of use
- Compliant to Directive 2002/95/EC, regarding Restriction of Hazardous Substances (RoHS)

## 1.3 Applications

- RF power amplifiers for GSM, GSM EDGE, W-CDMA and CDMA base stations and multi carrier applications in the 1800 MHz to 2000 MHz frequency range

## 2. Pinning information

**Table 2. Pinning**

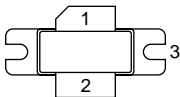
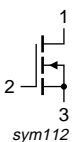
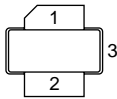
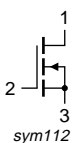
Pin	Description	Simplified outline	Graphic symbol
<b>BLF6G20-75 (SOT502A)</b>			
1	drain		
2	gate		
3	source		
<b>BLF6G20LS-75 (SOT502B)</b>			
1	drain		
2	gate		
3	source		

[1] Connected to flange.

## 3. Ordering information

**Table 3. Ordering information**

Type number	Package		
	Name	Description	Version
BLF6G20-75	-	flanged LDMOST ceramic package; 2 mounting holes; 2 leads	SOT502A
BLF6G20LS-75	-	earless flanged LDMOST ceramic package; 2 leads	SOT502B

## 4. Limiting values

**Table 4. Limiting values**

In accordance with the Absolute Maximum Rating System (IEC 60134).

Symbol	Parameter	Conditions	Min	Max	Unit
$V_{DS}$	drain-source voltage		-	65	V
$V_{GS}$	gate-source voltage		-0.5	+13	V
$I_D$	drain current		-	18	A
$T_{stg}$	storage temperature		-65	+150	°C
$T_j$	junction temperature		-	225	°C

## 5. Thermal characteristics

**Table 5. Thermal characteristics**

Symbol	Parameter	Conditions	Type	Typ	Unit
$R_{th(j-case)}$	thermal resistance from junction to case	$T_{case} = 80\text{ °C};$ $P_L = 29.5\text{ W (CW)}$	BLF6G20-75	0.9	K/W
			BLF6G20LS-75	0.75	K/W

## 6. Characteristics

**Table 6. Characteristics**

$T_j = 25\text{ °C}$  unless otherwise specified.

Symbol	Parameter	Conditions	Min	Typ	Max	Unit
$V_{(BR)DSS}$	drain-source breakdown voltage	$V_{GS} = 0\text{ V}; I_D = 0.5\text{ mA}$	65	-	-	V
$V_{GS(th)}$	gate-source threshold voltage	$V_{DS} = 10\text{ V}; I_D = 100\text{ mA}$	1.4	2	2.4	V
$V_{GSq}$	gate-source quiescent voltage	$V_{DS} = 28\text{ V}; I_D = 600\text{ mA}$	1.6	2.1	2.6	V
$I_{DSS}$	drain leakage current	$V_{GS} = 0\text{ V}; V_{DS} = 28\text{ V}$	-	-	3	$\mu\text{A}$
$I_{DSX}$	drain cut-off current	$V_{GS} = V_{GS(th)} + 3.75\text{ V};$ $V_{DS} = 10\text{ V}$	14.9	18.5	-	A
$I_{GSS}$	gate leakage current	$V_{GS} = 11\text{ V}; V_{DS} = 0\text{ V}$	-	-	300	nA
$g_{fs}$	forward transconductance	$V_{DS} = 10\text{ V}; I_D = 5\text{ A}$	-	7	-	S
$R_{DS(on)}$	drain-source on-state resistance	$V_{GS} = V_{GS(th)} + 3.75\text{ V};$ $I_D = 3.5\text{ A}$	-	0.15	0.235	$\Omega$
$C_{rs}$	feedback capacitance	$V_{GS} = 0\text{ V}; V_{DS} = 28\text{ V};$ $f = 1\text{ MHz}$	-	1.6	-	pF

## 7. Application information

**Table 7. Application information**

Mode of operation: GSM EDGE;  $f = 1930\text{ MHz}$  and  $1990\text{ MHz}$ ; RF performance at  $V_{DS} = 28\text{ V};$   $I_{Dq} = 550\text{ mA}; T_{case} = 25\text{ °C};$  unless otherwise specified; in a class-AB production test circuit.

Symbol	Parameter	Conditions	Min	Typ	Max	Unit
$P_{L(AV)}$	average output power		-	29.5	-	W
$G_p$	power gain	$P_{L(AV)} = 29.5\text{ W}$	17.5	19	-	dB
$RL_{in}$	input return loss	$P_{L(AV)} = 29.5\text{ W}$	-	-10	-5.5	dB
$\eta_D$	drain efficiency	$P_{L(AV)} = 29.5\text{ W}$	33.5	37.5	-	%
$ACPR_{400k}$	adjacent channel power ratio (400 kHz)	$P_{L(AV)} = 29.5\text{ W}$	-	-61.5	-59.5	dBc
$ACPR_{600k}$	adjacent channel power ratio (600 kHz)	$P_{L(AV)} = 29.5\text{ W}$	-	-73	-69.5	dBc
$EVM_{rms}$	RMS EDGE signal distortion error	$P_{L(AV)} = 29.5\text{ W}$	-	1.7	3	%
$EVM_M$	peak EDGE signal distortion error	$P_{L(AV)} = 29.5\text{ W}$	-	4.8	10	%

### 7.1 Ruggedness in class-AB operation

The BLF6G20-75 and BLF6G20LS-75 are capable of withstanding a load mismatch corresponding to  $VSWR = 10 : 1$  through all phases under the following conditions:  $V_{DS} = 28\text{ V}; I_{Dq} = 550\text{ mA}; P_L = 75\text{ W (CW)}; f = 1990\text{ MHz}.$

**7.2 One-tone CW**

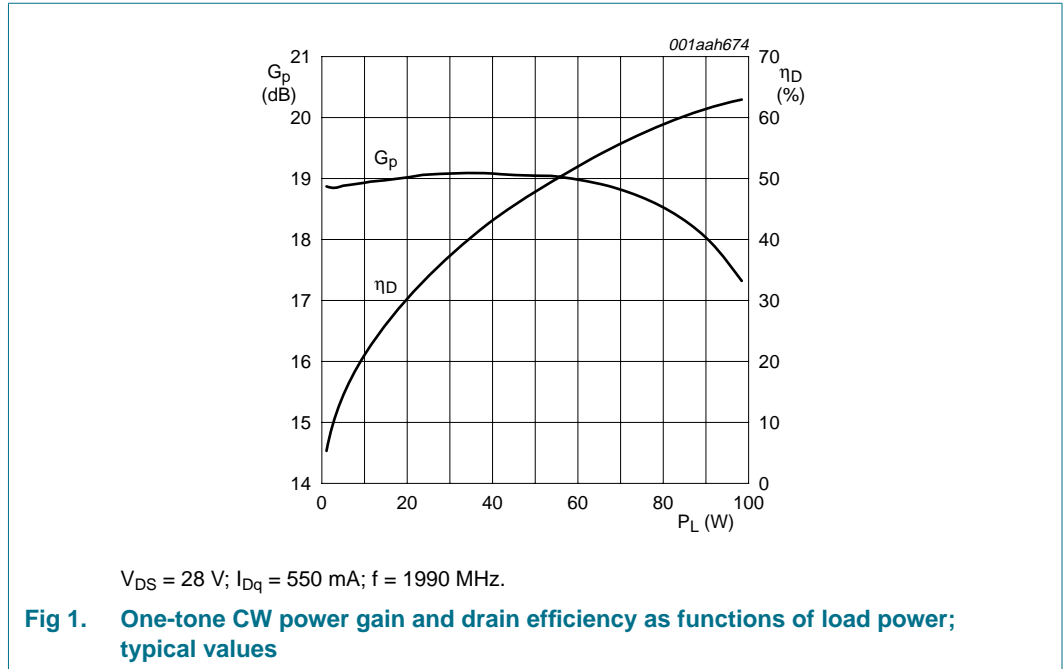

**7.3 Two-tone CW**

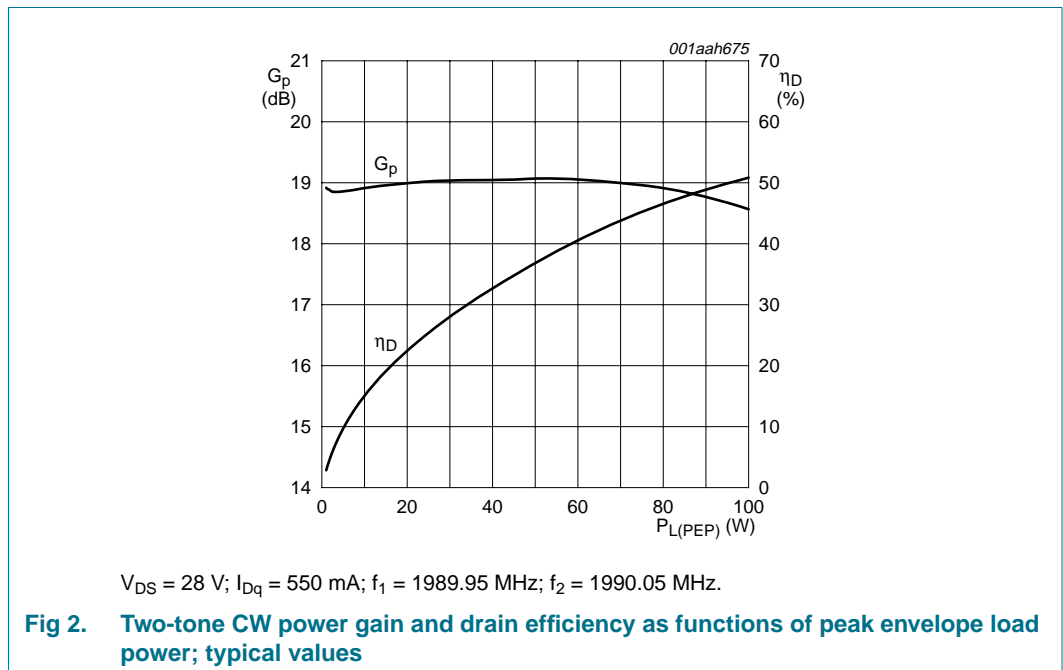

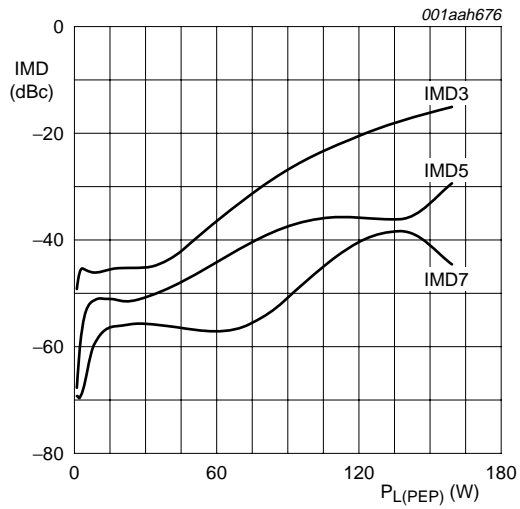

$V_{DS} = 28\text{ V}$ ;  $I_{Dq} = 550\text{ mA}$ ;  $f_1 = 1989.95\text{ MHz}$ ;  $f_2 = 1900.05\text{ MHz}$ .

**Fig 3. Two-tone CW intermodulation distortion as function of peak envelope load power; typical values**

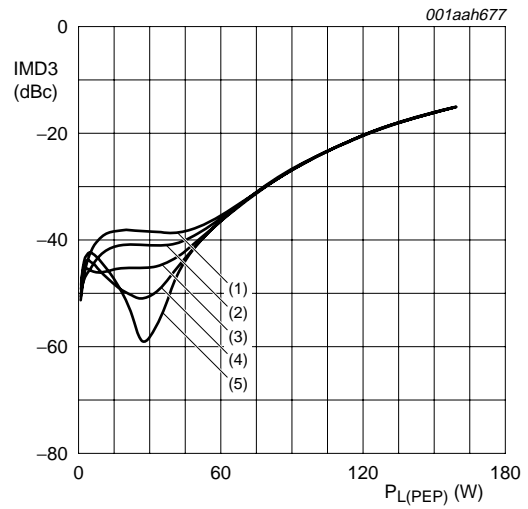

$V_{DS} = 28\text{ V}$ ;  $f_1 = 1989.95\text{ MHz}$ ;  $f_2 = 1900.05\text{ MHz}$ .

- (1) 450 MHz
- (2) 500 MHz
- (3) 550 MHz
- (4) 600 MHz
- (5) 650 MHz

**Fig 4. Third order intermodulation distortion as a function of peak envelope load power; typical values**

7.4 GSM-EDGE

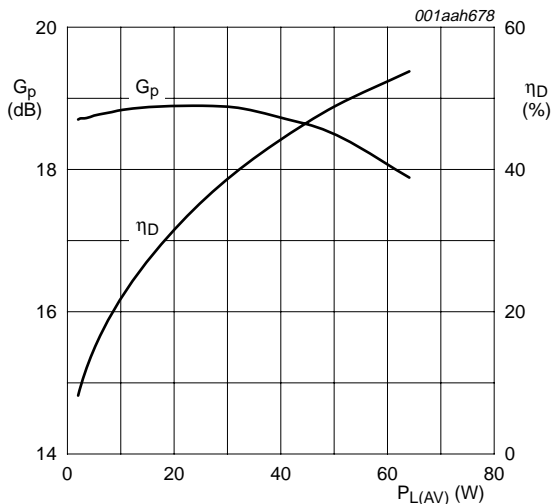

$V_{DS} = 28\text{ V}$ ;  $I_{Dq} = 550\text{ mA}$ ;  $f = 1990\text{ MHz}$ ;  $T_{case} = 25\text{ }^\circ\text{C}$ .

**Fig 5. GSM-EDGE power gain and drain efficiency as functions of average load power; typical values**

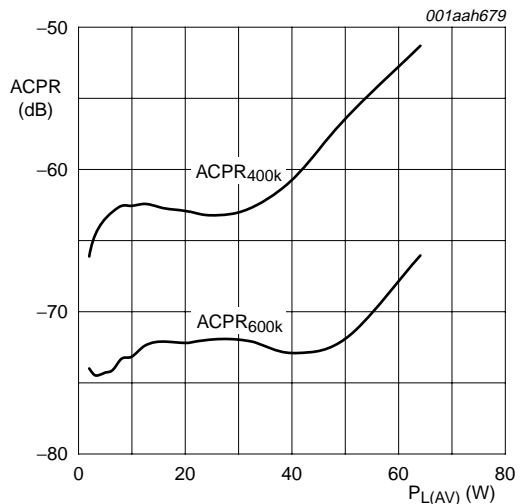

$V_{DS} = 28\text{ V}$ ;  $I_{Dq} = 550\text{ mA}$ ;  $f = 1990\text{ MHz}$ ;  $T_{case} = 25\text{ }^\circ\text{C}$ .

**Fig 6. GSM-EDGE ACPR at 400 kHz and at 600 kHz as functions of average load power; typical values**

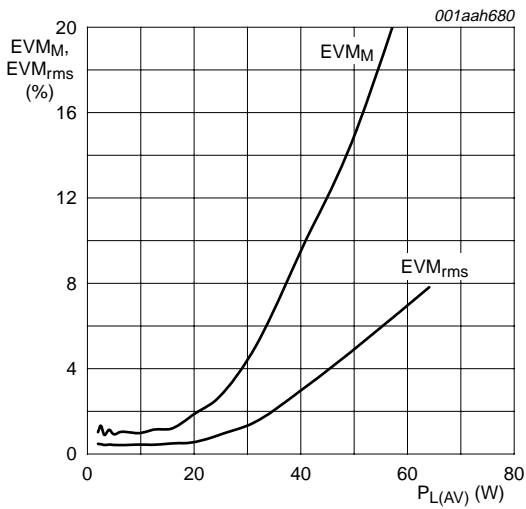

$V_{DS} = 28\text{ V}$ ;  $I_{Dq} = 550\text{ mA}$ ;  $f = 1990\text{ MHz}$ ;  $T_{case} = 25\text{ }^\circ\text{C}$ .

**Fig 7. GSM EDGE RMS EVM and peak EVM as functions of average load power; typical values**

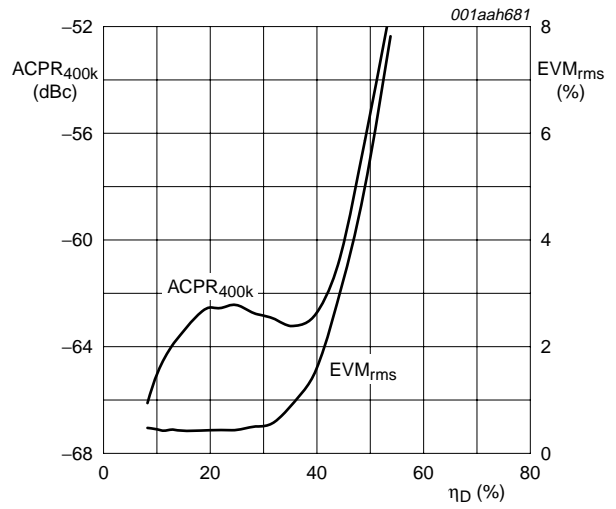

$V_{DS} = 28\text{ V}$ ;  $I_{Dq} = 550\text{ mA}$ ;  $f = 1990\text{ MHz}$ ;  $T_{case} = 25\text{ }^\circ\text{C}$ .

**Fig 8. GSM EDGE ACPR at 400 kHz and RMS EVM as functions of drain efficiency; typical values**

## 8. Test information

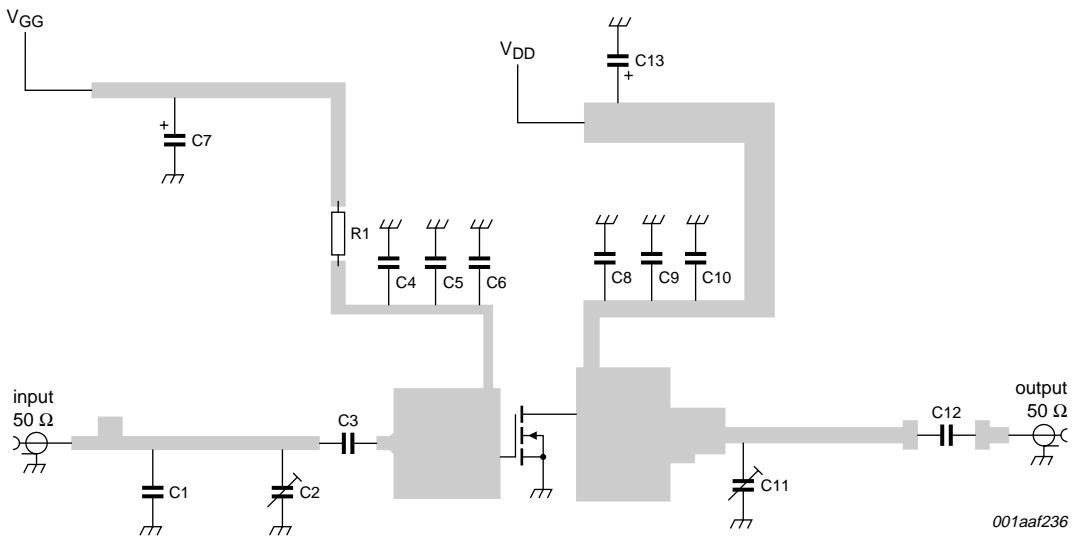

See [Table 8](#) for list of components.

**Fig 9. Test circuit for operation at 1990 MHz**

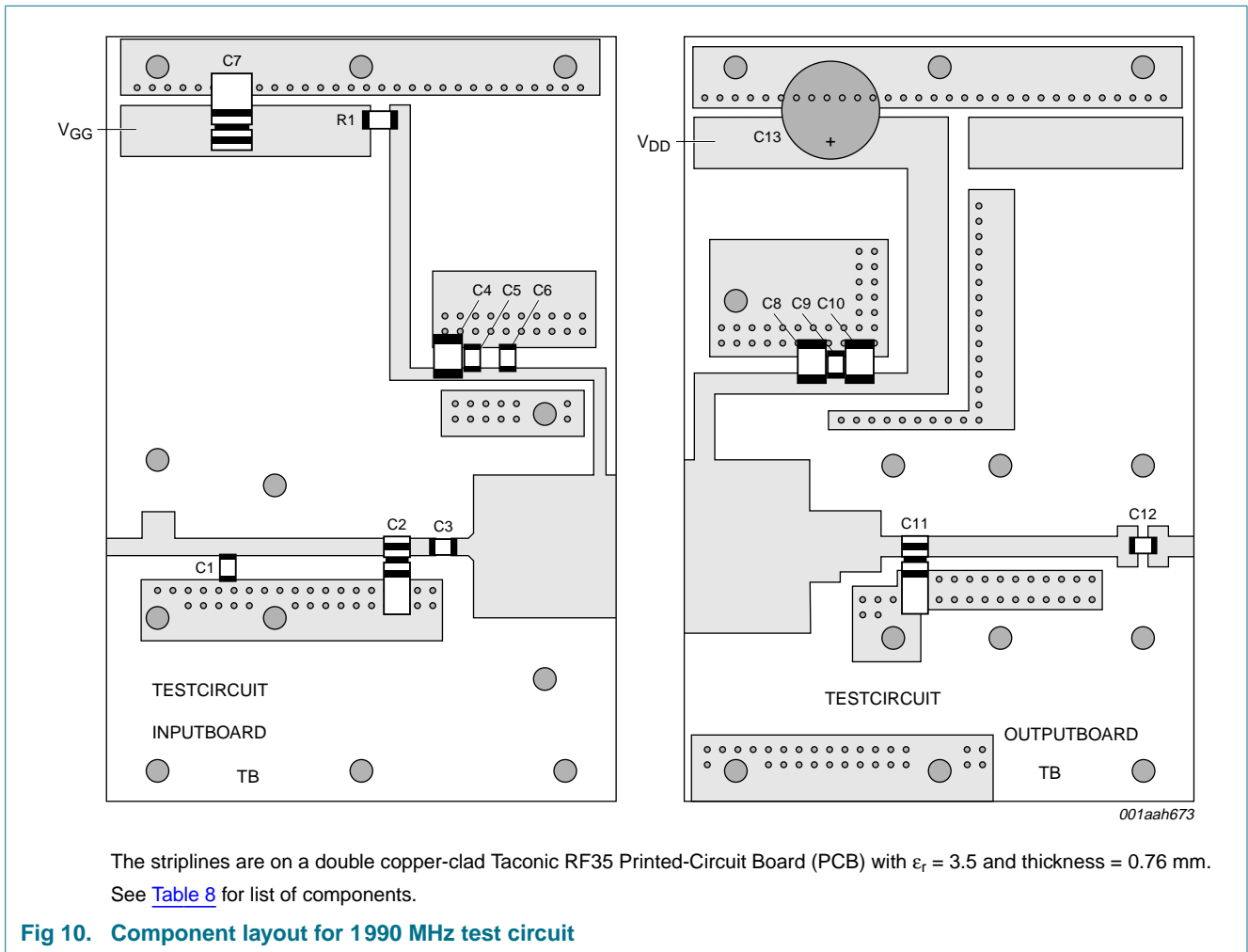

**Table 8. List of components (see [Figure 9](#) and [Figure 10](#))**

Component	Description	Value	Remarks
C1	multilayer ceramic chip capacitor	1 pF	[1]
C2, C11	gigahertz trimmer	0.6 pF to 4.5 pF	Temex AT SM270 or equivalent
C3, C6, C9	multilayer ceramic chip capacitor	12 pF	[1]
C4, C8, C10	multilayer ceramic chip capacitor	10 $\mu$ F; 50 V	TDK C5750X7R1H106M or equivalent
C5	multilayer ceramic chip capacitor	1.5 $\mu$ F; 50 V	TDK C3225X7R1H155M or equivalent
C7	tantalum capacitor	10 $\mu$ F; 50 V	Kemet T491 series or equivalent
C12	multilayer ceramic chip capacitor	12 pF	[1]
C13	electrolytic capacitor	220 $\mu$ F; 50 V	
R1	Philips chip resistor	5.6 $\Omega$ ; 1206	

[1] American Technical Ceramics type 100B or capacitor of same quality.

9. Package outline

Flanged LDMOST ceramic package; 2 mounting holes; 2 leads

SOT502A

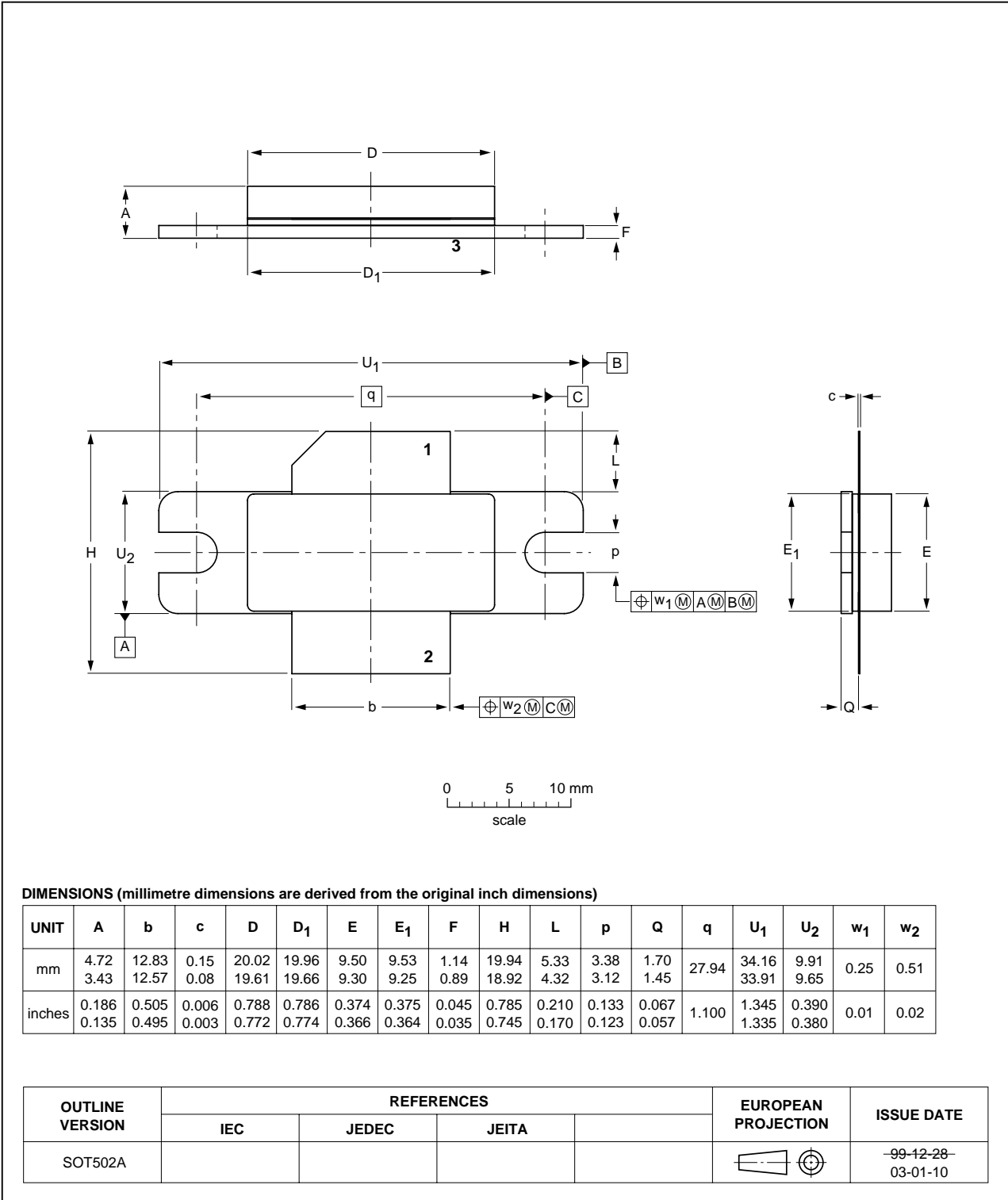

Fig 11. Package outline SOT502A



Earless flanged LDMOST ceramic package; 2 leads

SOT502B

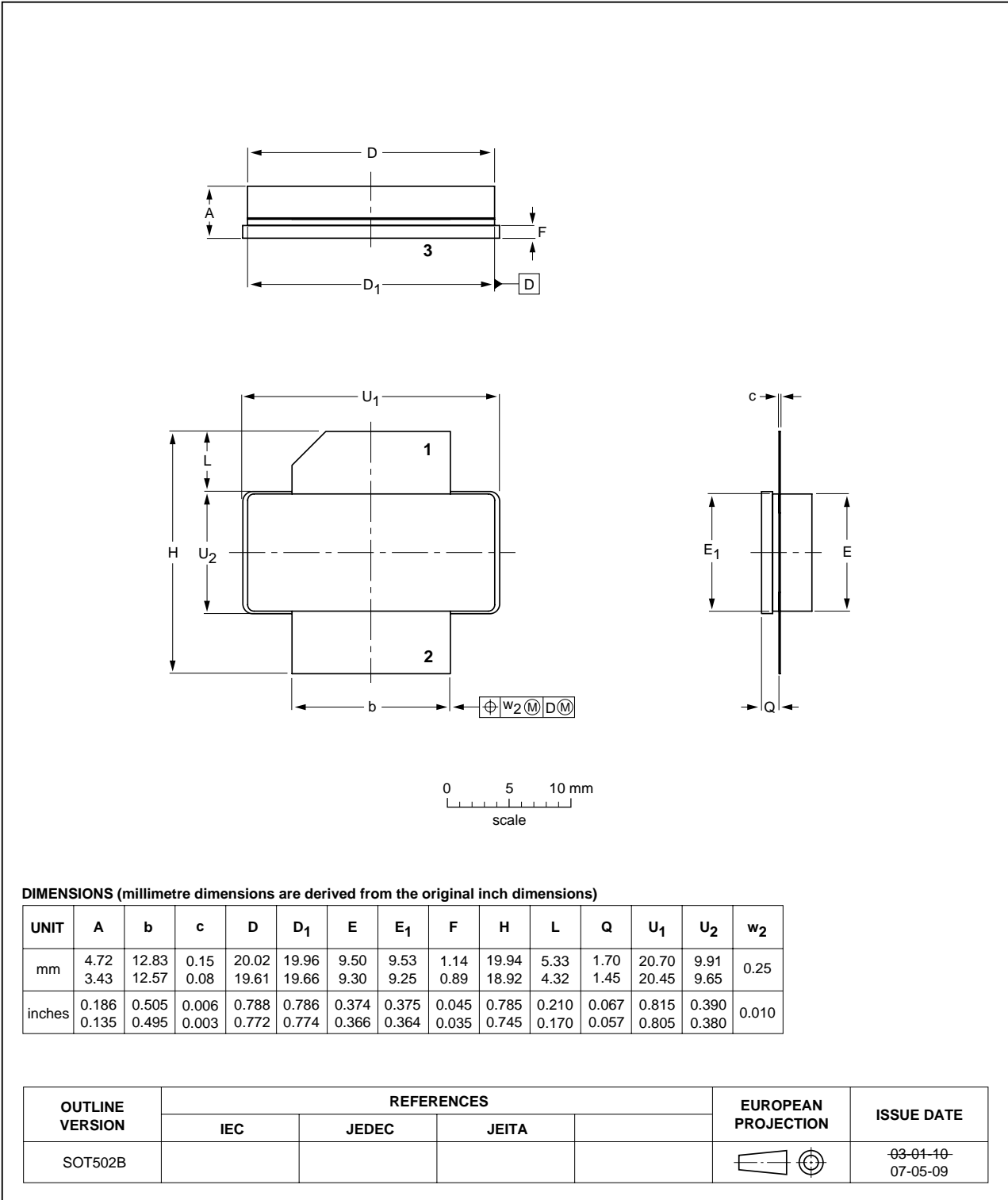

Fig 12. Package outline SOT502B

## 10. Abbreviations

**Table 9. Abbreviations**

Acronym	Description
CDMA	Code Division Multiple Access
CW	Continuous Wave
EDGE	Enhanced Data rates for GSM Evolution
EVM	Error Vector Magnitude
GSM	Global System for Mobile communications
LDMOS	Laterally Diffused Metal-Oxide Semiconductor
LDMOST	Laterally Diffused Metal-Oxide Semiconductor Transistor
RF	Radio Frequency
RMS	Root Mean Square
VSWR	Voltage Standing-Wave Ratio
W-CDMA	Wideband Code Division Multiple Access

## 11. Revision history

**Table 10. Revision history**

Document ID	Release date	Data sheet status	Change notice	Supersedes
BLF6G20-75_BLF6G20LS-75_2	20090209	Product data sheet	-	BLF6G20-75_1 BLF6G20LS-75_1
Modifications:				
				<ul style="list-style-type: none"> <li>The document now describes both the eared and earless version of this product: BLF6G20-75 and BLF6G20LS-75 respectively</li> <li><a href="#">Table 7 on page 3</a>: changed the minimum value for <math>\eta_D</math></li> <li><a href="#">Table 7 on page 3</a>: changed the maximum value for <math>EVM_{rms}</math></li> <li><a href="#">Table 7 on page 3</a>: changed the maximum value for <math>EVM_M</math></li> </ul>
BLF6G20-75_1	20080306	Preliminary data sheet	-	-
BLF6G20LS-75_1	20080218	Preliminary data sheet	-	-

## 12. Legal information

### 12.1 Data sheet status

Document status <sup>[1][2]</sup>	Product status <sup>[3]</sup>	Definition
Objective [short] data sheet	Development	This document contains data from the objective specification for product development.
Preliminary [short] data sheet	Qualification	This document contains data from the preliminary specification.
Product [short] data sheet	Production	This document contains the product specification.

[1] Please consult the most recently issued document before initiating or completing a design.

[2] The term 'short data sheet' is explained in section "Definitions".

[3] The product status of device(s) described in this document may have changed since this document was published and may differ in case of multiple devices. The latest product status information is available on the Internet at URL <http://www.nxp.com>.

### 12.2 Definitions

**Draft** — The document is a draft version only. The content is still under internal review and subject to formal approval, which may result in modifications or additions. NXP Semiconductors does not give any representations or warranties as to the accuracy or completeness of information included herein and shall have no liability for the consequences of use of such information.

**Short data sheet** — A short data sheet is an extract from a full data sheet with the same product type number(s) and title. A short data sheet is intended for quick reference only and should not be relied upon to contain detailed and full information. For detailed and full information see the relevant full data sheet, which is available on request via the local NXP Semiconductors sales office. In case of any inconsistency or conflict with the short data sheet, the full data sheet shall prevail.

### 12.3 Disclaimers

**General** — Information in this document is believed to be accurate and reliable. However, NXP Semiconductors does not give any representations or warranties, expressed or implied, as to the accuracy or completeness of such information and shall have no liability for the consequences of use of such information.

**Right to make changes** — NXP Semiconductors reserves the right to make changes to information published in this document, including without limitation specifications and product descriptions, at any time and without notice. This document supersedes and replaces all information supplied prior to the publication hereof.

**Suitability for use** — NXP Semiconductors products are not designed, authorized or warranted to be suitable for use in medical, military, aircraft, space or life support equipment, nor in applications where failure or

malfunction of an NXP Semiconductors product can reasonably be expected to result in personal injury, death or severe property or environmental damage. NXP Semiconductors accepts no liability for inclusion and/or use of NXP Semiconductors products in such equipment or applications and therefore such inclusion and/or use is at the customer's own risk.

**Applications** — Applications that are described herein for any of these products are for illustrative purposes only. NXP Semiconductors makes no representation or warranty that such applications will be suitable for the specified use without further testing or modification.

**Limiting values** — Stress above one or more limiting values (as defined in the Absolute Maximum Ratings System of IEC 60134) may cause permanent damage to the device. Limiting values are stress ratings only and operation of the device at these or any other conditions above those given in the Characteristics sections of this document is not implied. Exposure to limiting values for extended periods may affect device reliability.

**Terms and conditions of sale** — NXP Semiconductors products are sold subject to the general terms and conditions of commercial sale, as published at <http://www.nxp.com/profile/terms>, including those pertaining to warranty, intellectual property rights infringement and limitation of liability, unless explicitly otherwise agreed to in writing by NXP Semiconductors. In case of any inconsistency or conflict between information in this document and such terms and conditions, the latter will prevail.

**No offer to sell or license** — Nothing in this document may be interpreted or construed as an offer to sell products that is open for acceptance or the grant, conveyance or implication of any license under any copyrights, patents or other industrial or intellectual property rights.

### 12.4 Trademarks

Notice: All referenced brands, product names, service names and trademarks are the property of their respective owners.

## 13. Contact information

For more information, please visit: <http://www.nxp.com>

For sales office addresses, please send an email to: [salesaddresses@nxp.com](mailto:salesaddresses@nxp.com)

**14. Contents**

**1 Product profile . . . . . 1**

1.1 General description . . . . . 1

1.2 Features . . . . . 1

1.3 Applications . . . . . 2

**2 Pinning information . . . . . 2**

**3 Ordering information . . . . . 2**

**4 Limiting values . . . . . 2**

**5 Thermal characteristics . . . . . 3**

**6 Characteristics . . . . . 3**

**7 Application information . . . . . 3**

7.1 Ruggedness in class-AB operation . . . . . 3

7.2 One-tone CW . . . . . 4

7.3 Two-tone CW . . . . . 4

7.4 GSM-EDGE . . . . . 5

**8 Test information . . . . . 6**

**9 Package outline . . . . . 8**

**10 Abbreviations . . . . . 10**

**11 Revision history . . . . . 10**

**12 Legal information . . . . . 11**

12.1 Data sheet status . . . . . 11

12.2 Definitions . . . . . 11

12.3 Disclaimers . . . . . 11

12.4 Trademarks . . . . . 11

**13 Contact information . . . . . 11**

**14 Contents . . . . . 12**

Please be aware that important notices concerning this document and the product(s) described herein, have been included in section 'Legal information'.

